

# OCTOPLUS

## WARNING AND MEASUREMENT CONTROL UNIT FOR TOXIC AND FLAMMABLE GASES



## USER'S MANUAL



THE BELGIAN PIONEER IN GAS DETECTION

Copyright © 2013 by Dalemans s.a.

Article IMP00000062 • Revision V2R0 of 25/11/2013

*Any reproduction, whether partial or entire, made of this document, by whatever means, without the prior, written consent of Dalemans s.a. is strictly forbidden.*

*All of the information contained in this document is non-contractual and is subject to modification without warning.*

Dalemans s.a.  
Rue Jules Mélotte, 27 • B-4350 Remicourt (Belgium)  
Tel. +32(0)19 54 52 36 • Fax +32(0)19 54 55 34  
Email : [info@dalemans.com](mailto:info@dalemans.com)

# QUICK GUIDE

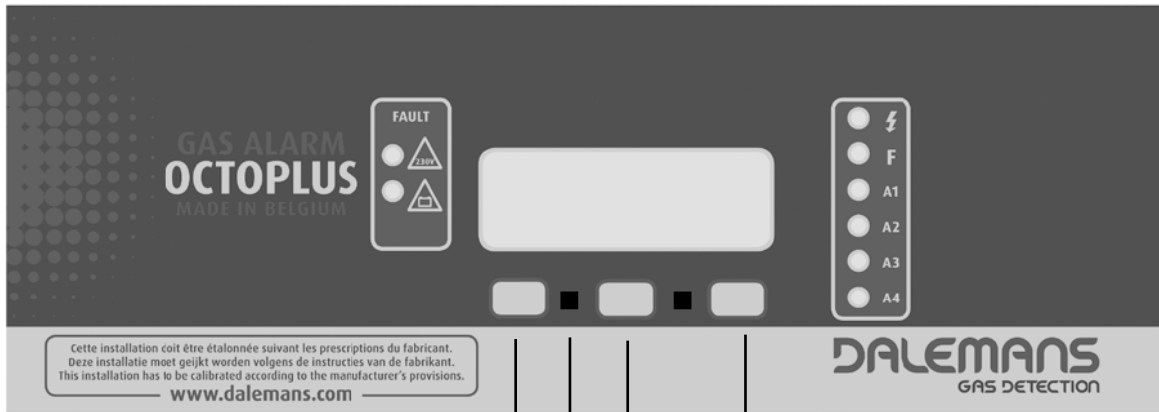

## B. Data viewing ..... 10

Display data of one particular detector

1X

## D. Restricted modifications ..... 13

- Parameters
  - Time ..... 13
  - Date ..... 14
  - Language ..... 14
- Messages
  - Failures ..... 15
- Test alarms ..... 16
- View
  - Status Relays ..... 17
  - Battery Voltage ..... 18
  - Maximum Values ..... 18

10"

1X

## B. Data viewing ..... 10

Display data of current detector

1X

## Cut off alarm ..... 12

10"

## C. Reset ..... 12

**Siren** - Cut off alarm  
**Alarms** - Reset levels of alarm  
**Max. Value** - Reset max. values

10"

## E. Advanced modifications ..... 19

Password : 1234

- Parameters modification
  - Levels of alarm ..... 20
  - Location ..... 21
  - Sensor number ..... 21
  - Inhibit output relays ..... 22
  - Versions ..... 22

 Front Panel key switch

 Hidden key switch (inside the Control Unit - see page 19)

*This page intentionally left blank*

# TABLE OF CONTENTS

- A. INTRODUCTION ..... 9**
  - a. Start-up, standby screen..... 9**
  - b. Notes ..... 9**
    - Symbols..... 9
- B. DATA VIEWING ..... 10**
  - STOP 1X..... 10
  - MENU 1X..... 10
  - a. Alarms..... 11**
    - Fail LED's ..... 11
    - Scanning display ..... 11
    - Explorer menu ..... 11
- C. RESET ..... 12**
  - RESET 1X ..... 12
  - RESET 10 seconds ..... 12
- D. RESTRICTED MODIFICATIONS ..... 13**
  - a. Parameters ..... 13**
    - Time..... 13
    - Date ..... 14
    - Language..... 14
  - b. Messages..... 15**
    - Failures ..... 15
  - c. Test alarms..... 16**
  - d. View..... 17**
    - Status Relays ..... 17
    - Battery Voltage ..... 18
    - Maximum Values ..... 18
- E. ADVANCED MODIFICATIONS..... 19**
  - a. Parameters modification..... 20**
    - Levels of alarm ..... 20
    - Location ..... 21
    - Sensor number ..... 21
  - b. Output relays inhibit..... 22**
  - c. Versions..... 22**
- F. FAIL CODES ..... 23**
  - Mother Board inputs ..... 23
  - Other..... 23
- G. INDEX..... 24**

## ENVIRONMENT



*The crossed-out wheeled bin logo on this product indicates that you are held to respect the regulation in force on the collection and recycling of waste electrical and electronic equipment (WEEE).*

*These provisions are intended to preserve the natural resources used for manufacturing this product and to avoid the dispersion of substances potentially harmful for the environment and human health.*

*Therefore, to dispose of your end-of-life product, you **MUST** hand it over to a designated collection point for the recycling of electrical and electronic equipment. For further information about the collection points in your area, contact your local city authority.*

# WARNINGS

***The fitter commits himself to comply with EC standards and with the installation instructions.***

***The installation must be carried out by qualified personnel.***

***All our products are tested and inspected before shipping.***

These instructions must be read carefully by any person who has or will have the responsibility for the installation, the use and/or the maintenance of this equipment.

The warranty provided by Dalemans will be voided if installation, use and maintenance of this equipment are not in accordance with the instructions given in this manual.

By respecting these instructions you guarantee the correct operation of the apparatus. Should you require any further information about the use or the maintenance of this product, do not hesitate to contact Dalemans PRIOR to carrying out installation works.

Each apparatus must be installed, operated and maintained according to the instructions, the warnings and the operational limits detailed in this manual.

Use only Dalemans original parts when you assume the maintenance of this product as specified in this manual. The use of non-Dalemans spare parts may seriously impair the performances of the apparatus.

Repair or maintenance attempts carried out without observing the procedures described in this manual or without the assistance of our after-sales service may prevent the equipment from working properly and, consequently, from ensuring the safety of the occupants of the building and of the plants.

This product must be installed in a dry and clean place. Install a protective screen or enclosure to avoid any direct exposure to the sun or possible projections of water or of polluting agents.

Do not hesitate to contact Dalemans for any additional information about the use or the maintenance of this product.

Dalemans reserves the right to modify its products in the advent of technical or other developments, at any moment and without warning.

# DISCLAIMER

Dalemans cannot be liable for direct or indirect damages arising out of the non-observance of its instructions.

Every effort has been made to ensure the accuracy of the information given in this document. Nevertheless, Dalemans s.a. declines any responsibility in the event of errors or omissions in this document.

# COPYRIGHT

The plans, drawings and information contained in this manual are the property of Dalemans s.a. and may not, by whatever means, be reproduced, communicated, translated or used without prior, written permission.

*This page intentionally left blank*



# A. INTRODUCTION

## a. Start-up, standby screen

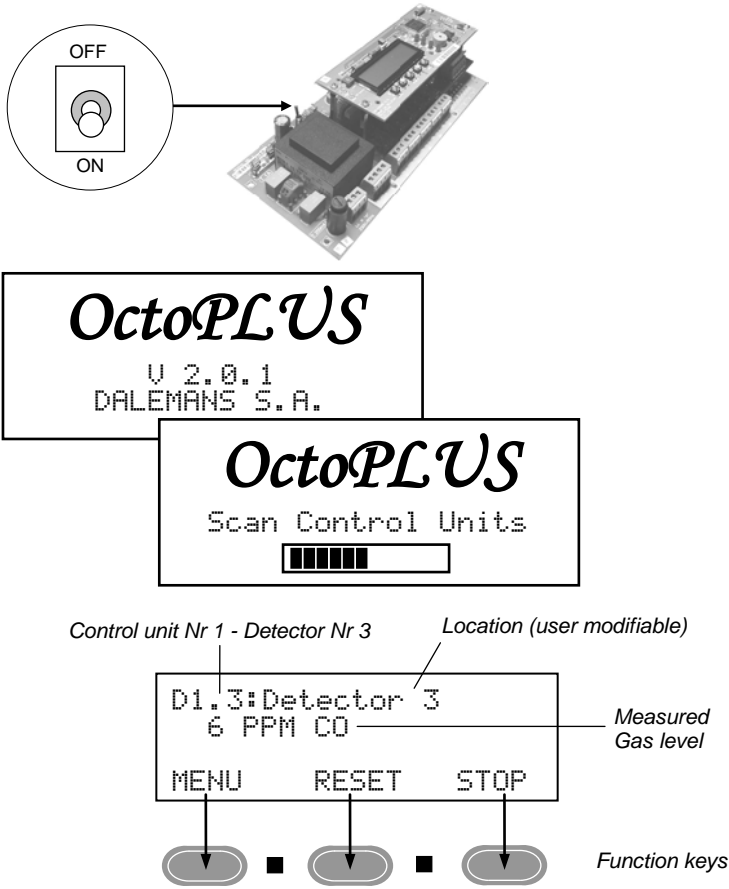

Turn ON the power switch of the mother board to power on the Control Unit.

At start-up, the screen displays :

- Software version
- Scanning of the Control Units.

After start-up, the screen scans and displays the data of the detectors in sequence.

The display is updated every 3 seconds.

## b. Notes

The zoom frame shows the key to press to perform the function.

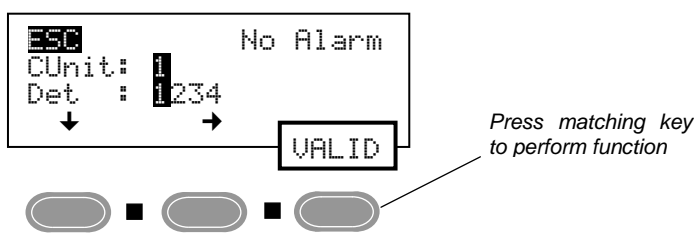

### ■ Symbols

- Validate selection
- Navigate through the menu
- Exit menu
- Press key 1X
- Keep key pressed for at least 5 seconds.
- Hidden key (inside the Control Unit - see page 19)

The screen can display up to 4 rows. Last row is dedicated to the function keys.

When stopping the display on a particular detector, data are displayed for 30 seconds then the screen starts again scanning the detectors in sequence.

Ensure to always validate selection.

You can navigate through menu or screen using the arrow keys :

- ← Move selection horizontally
- Move selection horizontally
- ↑ Move selection vertically
- ↓ Increase/decrease value

## B. DATA VIEWING

Measures, levels of alarm, averages, measuring ranges, faults...

Data of detectors can be displayed in two ways :

### ■ STOP 1X

- Press key STOP when the desired detector appears on the display.

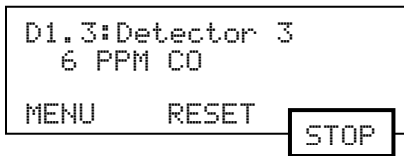

### ■ MENU 1X

- Press key MENU

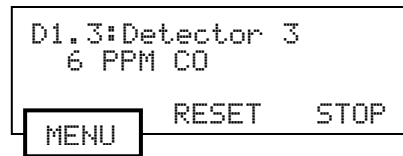

- Use keys ↓→ to select Control Unit and detector then press VALID to view data of the selected detector.

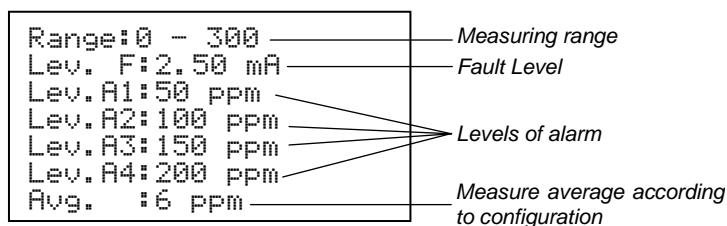
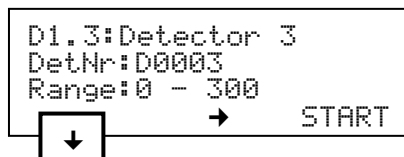
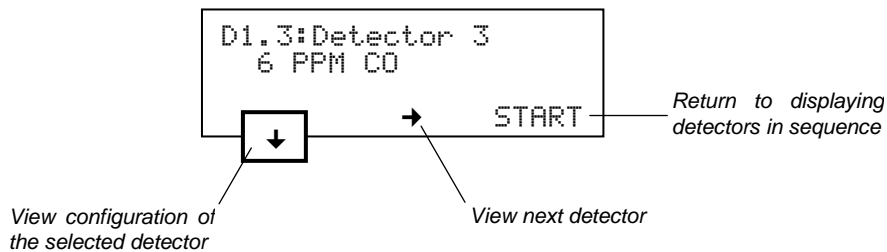
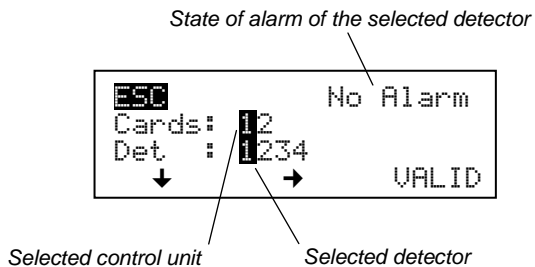

# a. Alarms

The front panel of the OctoPLUS has yellow and red LED's to give failure and/or alarm warning.

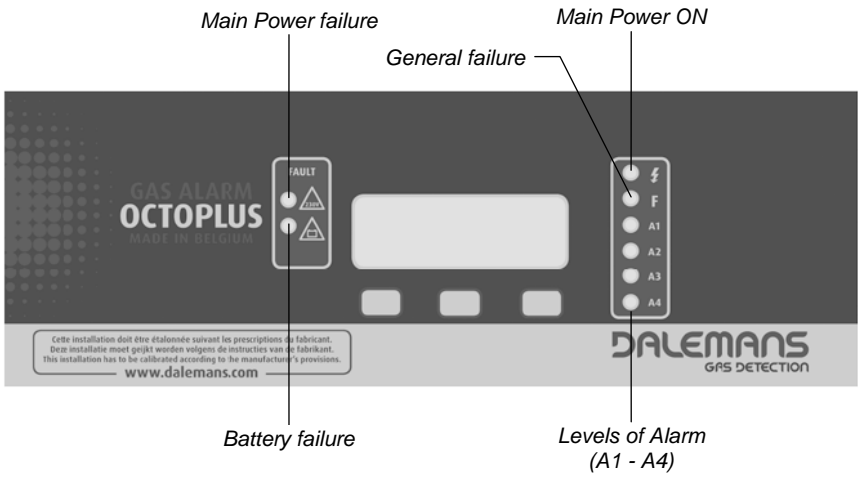

## ■ LED indicators

- **General failure** : yellow LED ON when general failure and/or battery failure is detected.  
e.g. : broken cable, battery voltage too low, ...
- **Main Power failure** : yellow LED ON when OctoPLUS switches on battery upon main power supply failure (230 Vac).
- **Battery failure** : yellow LED ON when battery failure is detected (e.g. battery voltage too low).
- **Levels of Alarms** : red LED ON when an alarm is detected (gas concentration over level of alarm).

Failures and alarms can be read in the scanning screen or by **MENU** function.

Use **STOP** or **MENU** function to display a detector (see previous page).

## ■ Scanning screen

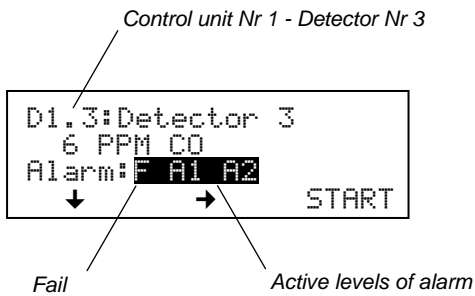

## ■ Explorer menu

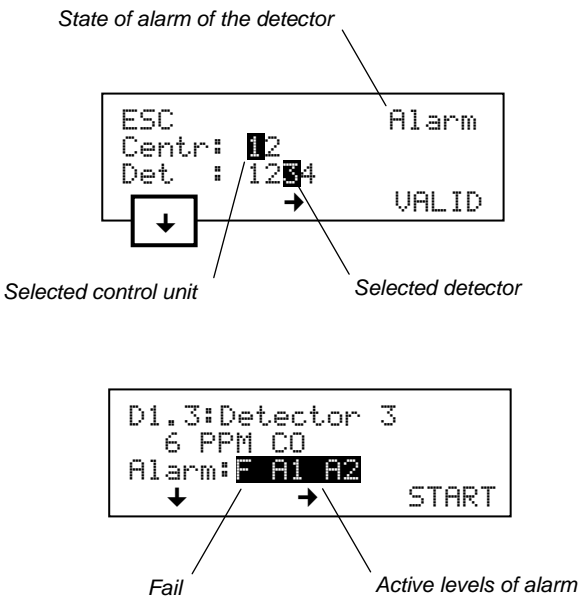

## C. RESET

This function allows alarm cut-off and reset of levels of alarm and of measured values.

### ■ RESET 1X

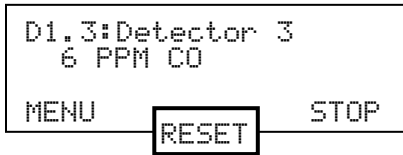

The OctoPLUS can be configured in two different modes :

- Normal mode
- Alarm cut-off mode

- **Normal mode**

**RESET 1X** : stops alarm and reset level of alarm if gas concentration is below level of alarm.

- **Alarm cut-off mode**

**RESET 1X** : stops alarm.

**RESET 2X** : output relays return to normal position if gas concentration is below level of alarm.

**Note :**

"Normal" and "Cut-off alarm" mode configuration requires OctoPLUS configuration software.

### ■ RESET 10 seconds



This function is especially used for resetting max. values and latched alarms.

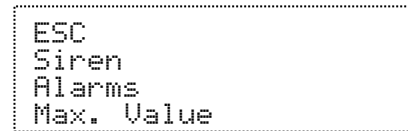
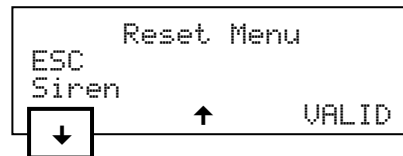

Select the item to reset with **↑↓** and press **VALID**.

- Siren** : Cut off alarm
- Alarms** : Reset levels of alarm
- Max. Value** : Reset Max. measured values

Reset is immediately performed and confirmed by the following screen :

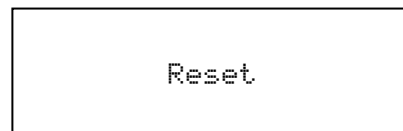

# D. RESTRICTED MODIFICATIONS

Time, date, language, messages, alarm test, relays status, battery voltage, max. values.

## a. Parameters

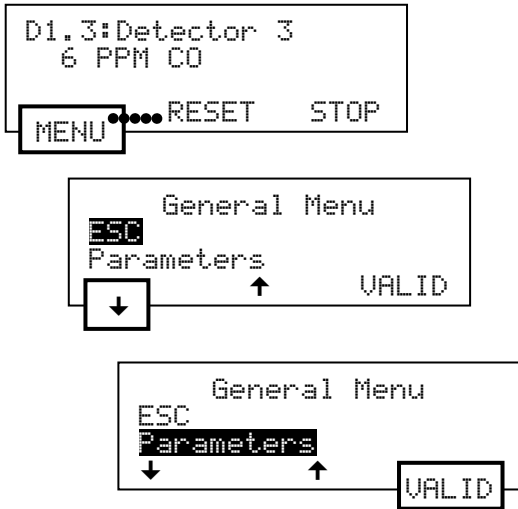

Hold key **MENU** pressed until General Menu appears.

Select **Parameters** using keys **↓↑** and press key **VALID**. To exit menu select **ESC** and press key **VALID**.

### ■ Time

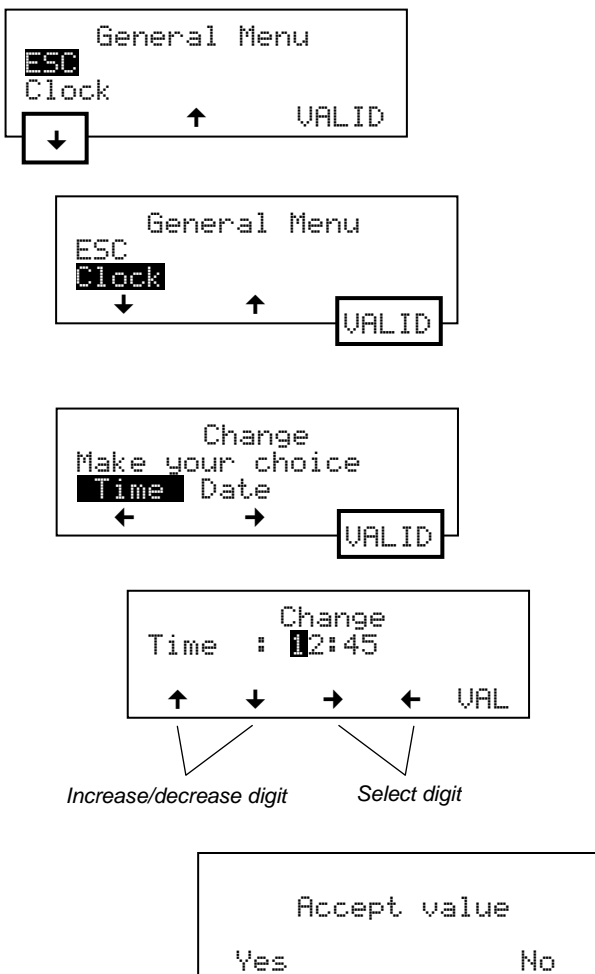

To change time, select **Clock** from the Parameters Menu (see above) using keys **↓↑** and press **VALID**.

Select **Time** with keys **←→** then press **VALID**.

Move selection using keys **→←**, then adjust digit value with **↑↓** and press key **VALID** to save.

**Note :**  
Keys **↓←** are inside the Control Unit enclosure (see page 19).

Press **YES** to save or **NO** to discard the modifications.

## ■ Date

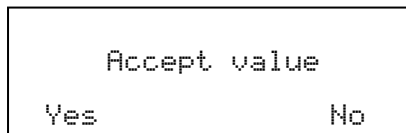
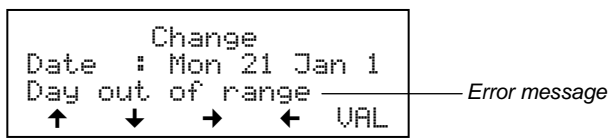
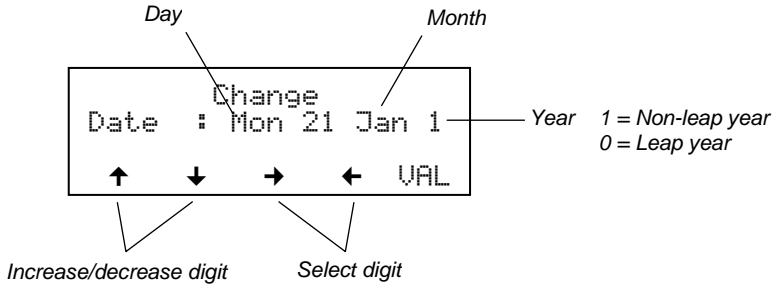

To change date select **Date** from the Clock Menu (see page 13) and press key **VALID**.

Move selection using keys  $\leftarrow \rightarrow$  then adjust value with  $\uparrow \downarrow$  and press **VALID** to save.

**Note :**

Keys  $\downarrow \leftarrow$  are inside the Control Unit enclosure (see page 19).

If wrong values are entered an error message will appear.

Press **YES** to save or **NO** to discard the modifications.

## ■ Language

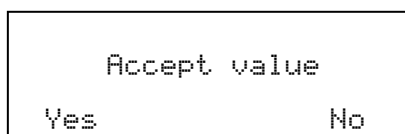
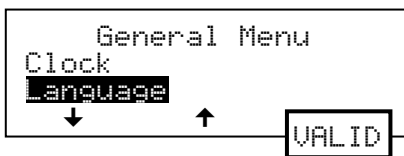
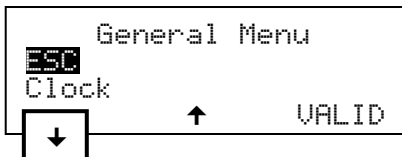

To change the menu language, select **Language** from the Parameter Menu (see page 13) using keys  $\downarrow \uparrow$  and press **VALID**.

Select desired language using keys  $\rightarrow \leftarrow$  and press **VALID** to save :

- NL** : Dutch
- FR** : French
- UK** : English

Press **YES** to save or **NO** to discard the modifications.

## b. Messages

### ■ Failures

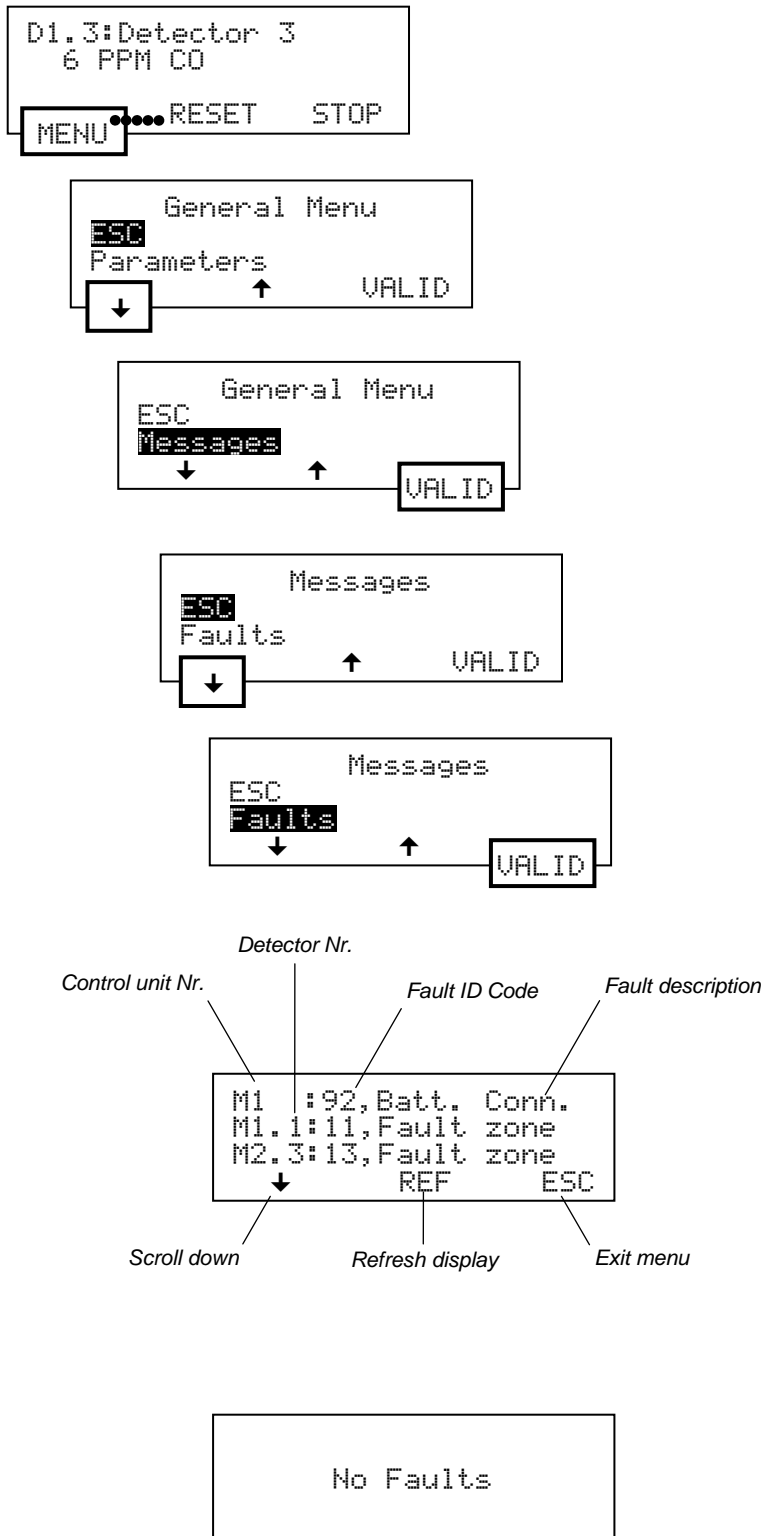

To display failure messages hold key **MENU** pressed until General Menu appears.

From the General Menu, select **Messages** using keys **↓↑** and press **VALID**. To exit menu select **ESC** and press key **VALID**.

Select **Faults** using keys **↓↑** and press **VALID**.

Scroll down using keys **↓↑** to see the list of failures (Faults) which occurred on the system.

- **REF** : even if a failure is no longer active it still appears in the list of faults until you refresh the display by pressing the key **REF**.
- **Fault ID Code** : every failure is identified by a code and a brief description. Faults ID Codes are listed at page 23.

If there is no failure the message "No Faults" appears instead of the list of failures.

## c. Test alarms

```
D1.3:Detector 3
6 PPM CO
MENU RESET STOP
```

```
General Menu
ESC
Parameters
↓ ↑ VALID
```

```
General Menu
Messages
Test Alarms
↓ ↑ VALID
```

Control unit Nr

```
ESC Select Sens.
Card: 1
Det : 1234
↓ → VALID
```

Detector Nr

```
Gas level Loop current
Test Alarms
0ppm I: 4,00mA
A1: No Alarm
START STOP ESC
Start test Stop test Exit menu
```

No Alarm : no active alarm  
 D : Fail alarm active  
 A1 : Level of alarm A1 active  
 A2 : Level of alarm A2 active  
 A3 : Level of alarm A3 active  
 A4 : Level of alarm A4 active

To perform alarm simulation, enter General Menu by holding the key **MENU** pressed.

Scroll down and select **Test Alarms** using keys **↓↑** and press **VALID**.

Use keys **↓→** to select Control unit and Detector for which the alarm test has to be performed. Press key **VALID**.

Press key **START** to start the test.

Press **STOP** to stop the test.

Press **ESC** to exit test.

During alarm test, yellow and red LED's of the control panel and output relays operate according to software configuration.



## d. View

Status of output relays, battery voltage, max. measured values, ...

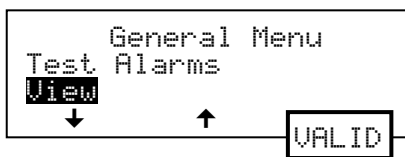
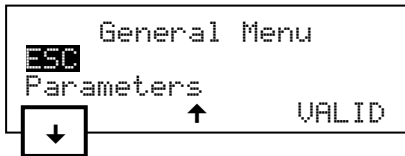

To enter the View Menu, hold the key **MENU** pressed.

Select **View** using keys ↓↑ and press **VALID**.

### ■ Status Relays

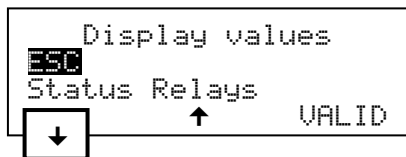

This function allows viewing the status of each output relay and checking whether it is activated or not.

From View Menu, select **Status Relays** using the keys ↓↑ and press **VALID**.

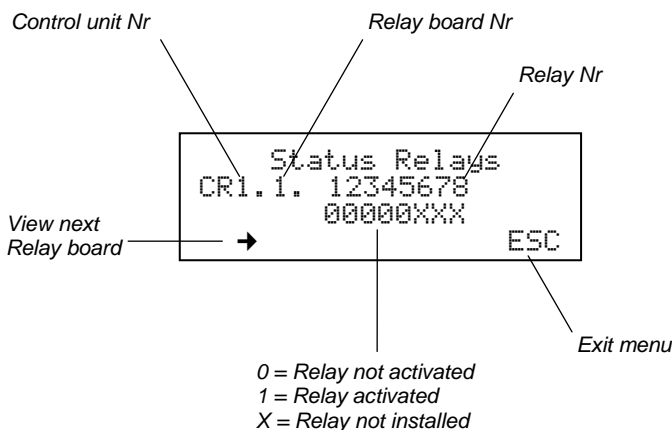

The screen displays status of output relays for each Control unit.

Press key → to view next Relay Board.

Relay Board Nr 1 relates to the 5 relays of the Mother Board of the Control unit.

Relay Boards from Nr 2 on relate to additional Relay Boards (8 relays).

## ■ Battery Voltage

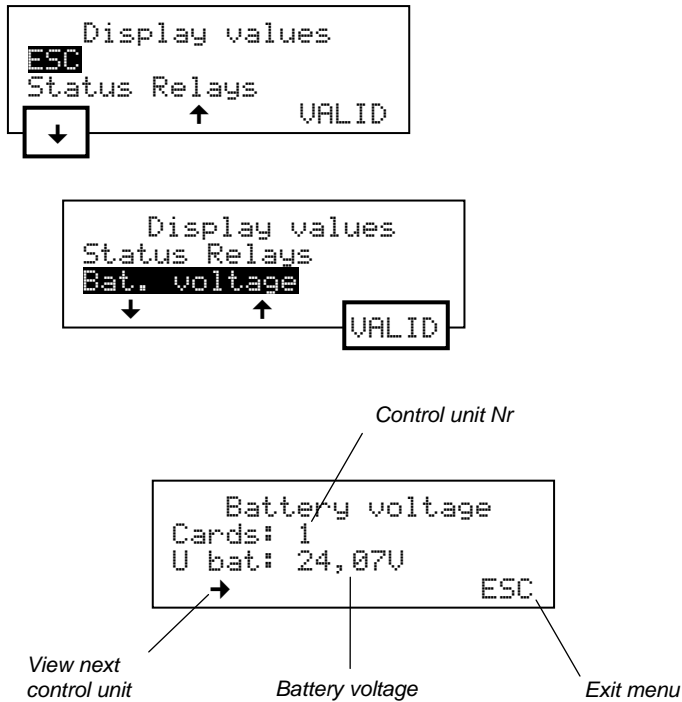

This function allows reading the battery level.

From View Menu (see above), scroll down and select **Bat. voltage** using the keys ↓↑. Press key **VALID**.

The screen displays the battery voltage level for each Control unit.

Press key → to view next Control unit.

## ■ Maximum Values

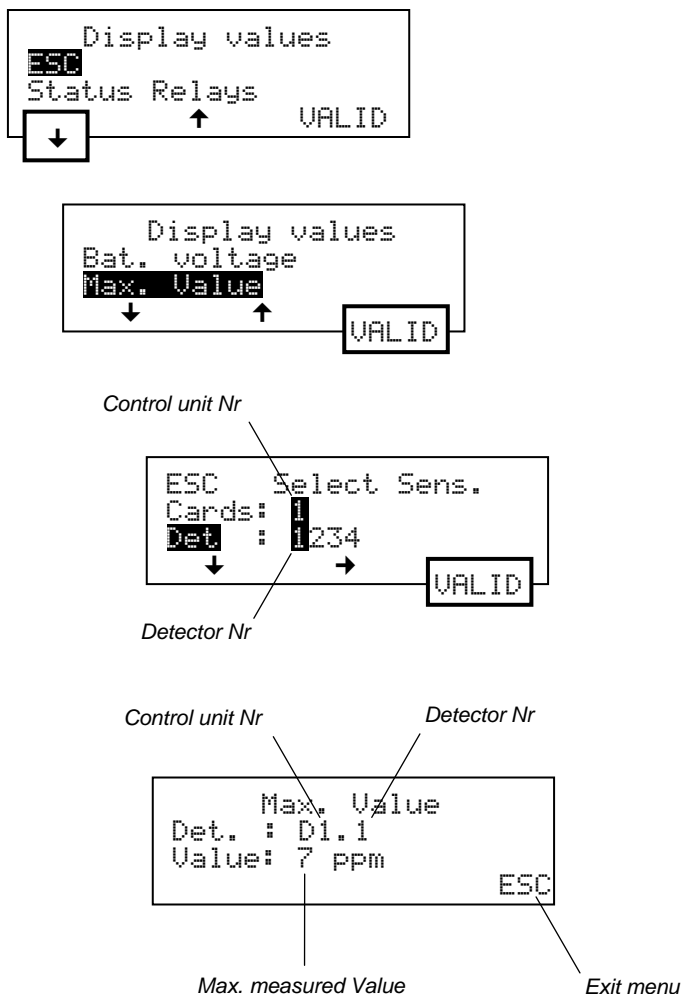

This function allows reading the maximum values measured by the detectors.

From View Menu (see page 17), scroll down and select **Max. Value** using the keys ↓↑. Press key **VALID**.

Use keys ↓→ to select Control unit and Detector whose you want to view max. value then press key **VALID**.

# E. ADVANCED MODIFICATIONS

For modifying advanced parameters such as relays inhibition, level of alarm or detector number, a PIN code is required.

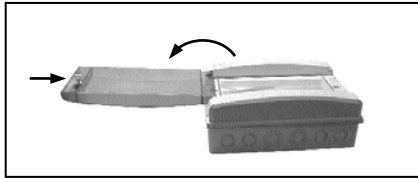

Fig. 1

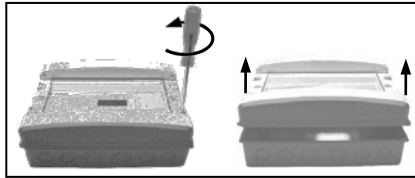

Fig. 2

Advanced Modification Menu requires the use of a switch key which is inside the Control unit.

To open the OctoPLUS Housing :

1. Remove the transparent lid (Fig. 1).
2. Unscrew the 4 screws with a suitable flat screwdriver and remove the lid (Fig. 2).

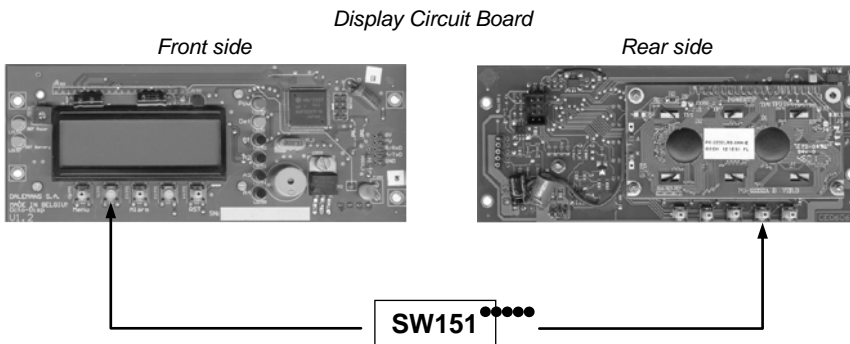
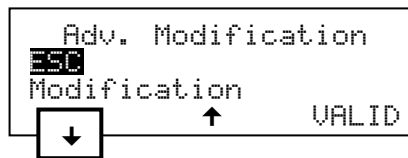
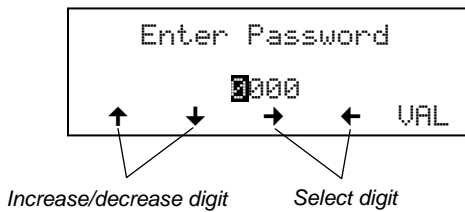

Fig. 3

To enter Advanced Modification Menu hold the key **SW151** pressed. This key switch is on both sides of the Display Circuit Board (Fig. 3).

**Password : 1234**

To enter password, move selection with keys **↑↓**, change value of digit with keys **→←**, and press **VALID**.



To proceed with advanced modification, select desired option with keys **↑↓** and press **VALID**.

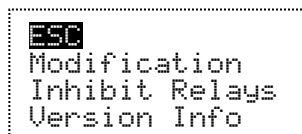

To exit menu, select **ESC** and press key **VALID**.

## a. Parameters modification

Levels of alarm, detector location, detector number.

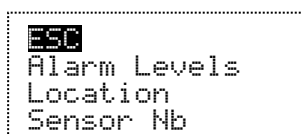
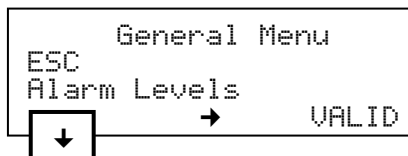
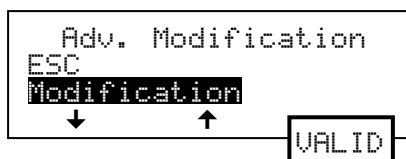

To enter Parameters Modification menu, from Advanced Modification menu (see previous page), select **Modification** with keys  $\downarrow\uparrow$  and press **VALID**.

To proceed with modification, select the parameter to modify with keys  $\uparrow\downarrow$  and press **VALID**.

To exit menu, select **ESC** and press key **VALID**.

### ■ Levels of alarm

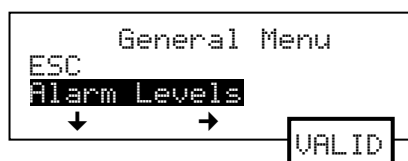

Control unit Nr



Detector Nr

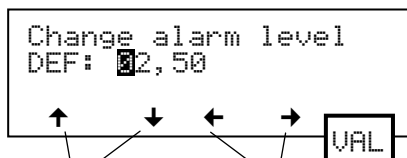
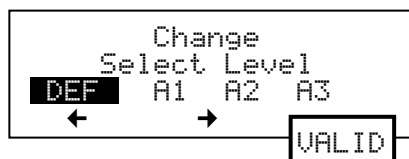

Increase/decrease digit

Select digit

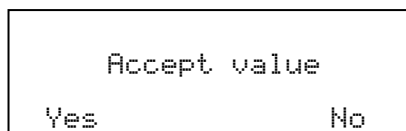

Use keys  $\downarrow\rightarrow$  to select Control unit and Detector you want to modify then press key **VALID**.

Select the level of alarm to modify with the keys  $\leftarrow\rightarrow$  then press **VALID**.

**Note** : scroll further levels with key  $\rightarrow$ .

Move selection with keys  $\rightarrow\leftarrow$ , increase/decrease digit value with keys  $\uparrow\downarrow$  then press **VAL**.

DEF : Level of alarm Fail  
 A1 : 1<sup>st</sup> level of alarm  
 A2 : 2<sup>nd</sup> level of alarm  
 A3 : 3<sup>rd</sup> level of alarm  
 A4 : 4<sup>th</sup> level of alarm

Press **YES** to save or **NO** to discard the modifications.

## ■ Location

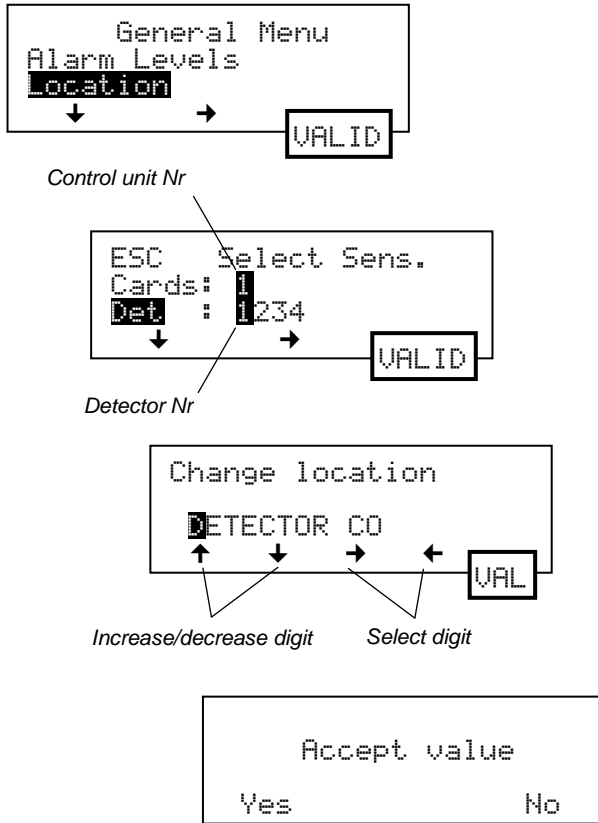

Use keys  $\downarrow\rightarrow$  to select Control unit and Detector you want to modify then press key **VALID**.

Move selection with keys  $\rightarrow\leftarrow$ , change digit with keys  $\uparrow\downarrow$  then press **VAL**.

Press **YES** to save or **NO** to discard the modifications.

## ■ Sensor number

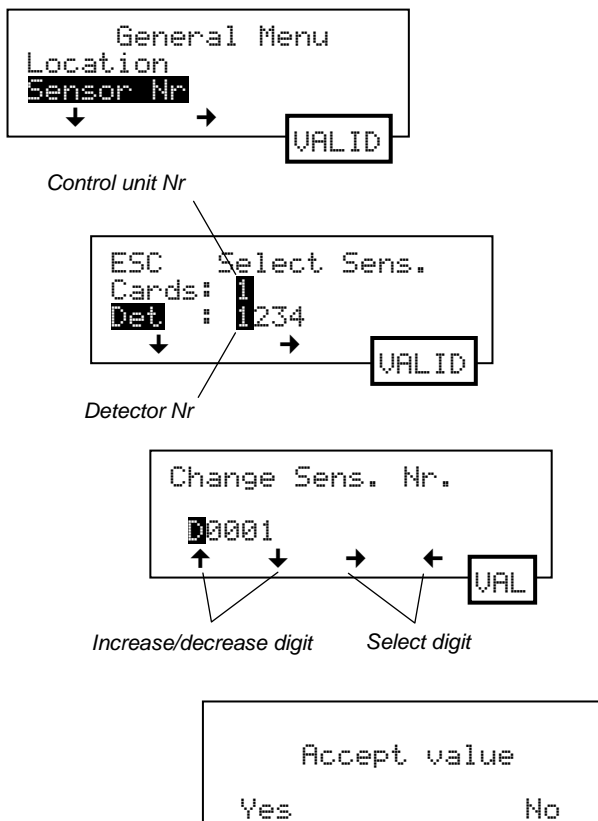

Use keys  $\downarrow\rightarrow$  to select Control unit and Detector you want to modify then press key **VALID**.

Move selection with keys  $\rightarrow\leftarrow$ , change digit with keys  $\uparrow\downarrow$  then press **VAL**.

Press **YES** to save or **NO** to discard the modifications.

## b. Inhibit output relays

The purpose of this function is to inhibit output relays for 30 seconds in order to allow testing the detectors without any actuation of the output devices (e.g. valve, ventilation, ...).

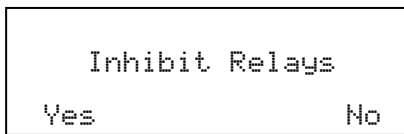
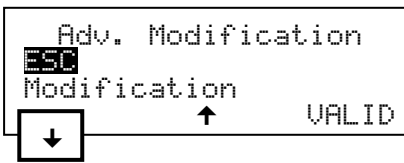

Enter in Advanced Modification menu (see page 19).

Select **Inhibit Relays** with keys ↓↑ and press **VALID**.

Press **Yes** to inhibit relays or **No** to abort and exit menu.

## c. Versions

This function allows viewing the version of the software of the OctoPLUS.

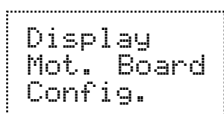
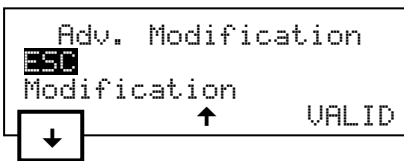

Enter in Advanced Modification menu (see page 19).

Select **Version Info** with keys ↓↑ and press **VALID**.

Use key → to Select the Control unit to view and press **VALID**.

Press key ↓ to scroll down.

**Display** : Version of the software of the display board.

**Mot. Board** : Version of the software of the mother board.

**Config.** : Version of the configuration.

## F. FAIL CODES

---

### ■ Mother Board inputs

The first digit of the fail code gives the address of the mother board. The second digit gives the address of the input concerned by the failure.

#### **Examples :**

*18 : failure on input Nr 8 of mother board Nr 1.*

*25 : failure on input Nr 5 of mother board Nr 2.*

*61 : failure on input Nr 1 of mother board Nr 6.*

- Possible fail codes for mother board Nr 1  
11 - 12 - 13 - 14 - 15 - 16 - 17 - 18
- Possible fail codes for mother board Nr 2  
21 - 22 - 23 - 24 - 25 - 26 - 27 - 28
- Possible fail codes for mother board Nr 3  
31 - 32 - 33 - 34 - 35 - 36 - 37 - 38
- Possible fail codes for mother board Nr 4  
41 - 42 - 43 - 44 - 45 - 46 - 47 - 48
- Possible fail codes for mother board Nr 5  
51 - 52 - 53 - 54 - 55 - 56 - 57 - 58
- Possible fail codes for mother board Nr 6  
61 - 62 - 63 - 64 - 65 - 66 - 67 - 68
- Possible fail codes for mother board Nr 7  
71 - 72 - 73 - 74 - 75 - 76 - 77 - 78
- Possible fail codes for mother board Nr 8  
81 - 82 - 83 - 84 - 85 - 86 - 87 - 88

### ■ Other

- 01 Communication failure on clock.
- 02 Communication failure on EEPROM.
- 03 Program failure with reference to configuration.
- 04 Communication failure on display.
- 08 EEPROM failure.
  
- 90 Battery too low.
- 91 Main power failure (230 Vac).
- 92 Battery not connected.

# G. INDEX

---

ALARM		PARAMETERS	
Cut off .....	12	Date .....	14
Display .....	11	Language .....	14
Test .....	16	Levels of Alarm .....	20
BATTERY		Location .....	21
Alarm LED .....	11	Password .....	19
Level .....	18	Sensor Number.....	21
CLOCK.....	13	Time.....	13
DATE.....	14	RELAYS	
DETECTOR		Inhibit .....	22
Alarm LED .....	11	View .....	17
Range .....	10	RESET	
Viewing Data .....	10	Alarms.....	12
ERROR CODES .....	23	Levels of Alarm .....	12
FAIL		Max. Values .....	12
Display .....	15	Siren .....	12
Fail Codes.....	23	SIREN.....	12
LED .....	11	SYMBOLS.....	9
FUNCTION KEYS .....	9	TEST ALARMS .....	16
LANGUAGE.....	14	TIME.....	13
LEVELS OF ALARM		VERSION INFO.....	22
Modification .....	20	VIEW	
Reset .....	12	Battery Level.....	18
MAX. VALUES .....	18	Max. Values .....	18
MESSAGES .....	15	Output Relays .....	17



# NOTES

A series of horizontal dotted lines for writing notes, spanning the width of the page.





Rue Jules Mélotte 27 • B-4350 Remicourt  
Tel. +32 (0)19 54 52 36  
Fax +32 (0)19 54 55 34  
info@dalemans.com

**OFFICIAL DEALER**

A rectangular stamp area with rounded corners, a horizontal dashed line, and a light gray gradient background.

**[www.dalemans.com](http://www.dalemans.com)**

THE BELGIAN PIONEER IN GAS DETECTION