

Honeywell

krom
schroder

Pressure gauges KFM, RFM

Technical Information · GB
10 Edition 01.17

- Overpressure-proof
- High indicating accuracy
- Zero point correction



Contents

Pressure gauges KFM, RFM	1	6.4 Positive pressure protection UDS	12
Contents	2	7 Technical data	13
1 Application	3	7.1 Dimensions.....	14
1.1 Application examples.....	4	8 Converting units	15
1.1.1 Low gas pressure monitoring.....	4	9 Maintenance cycles	15
1.1.2 Differential pressure monitoring	4	Feedback	16
1.1.3 Systems leak tightness check.....	4	Contact	16
2 Certification	5		
3 Function	6		
3.1 RFM	6		
3.2 KFM	7		
4 Selection	8		
4.1 KFM, RFM.....	8		
4.1.1 Selection table.....	8		
4.1.2 Type code.....	8		
5 Project planning information	9		
5.1 Installation.....	9		
5.2 Installation position	9		
5.3 Outdoor applications	9		
5.4 Pressure surges.....	9		
5.5 Zero point correction	9		
5.6 Oxygen and acetylene.....	10		
5.6.1 Safety pattern version.....	10		
5.7 Discharge bore.....	10		
5.8 Indicating accuracy.....	10		
5.8.1 Indicating error	10		
5.8.2 Accuracy classes	10		
6 Accessories	11		
6.1 Manual cock DH	11		
6.1.1 Technical data	11		
6.2 Pressure gauge shut-off valve MH	11		
6.2.1 Technical data	11		
6.3 Pressure gauge seal	12		

1 Application



Pressure gauge with capsule element KFM



Pressure gauge with Bourdon tube RFM

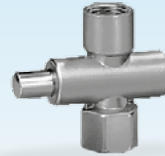

Manual cock DH

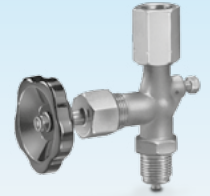

Pressure gauge shut-off valve MH

Pressure gauges with capsule element or Bourdon tube are mechanical pressure measuring instruments with spring-loaded measuring elements.

They are designed to display static gas and air pressures.

Pressure gauge with capsule element KFM

Pressure gauges with a capsule element to EN 837-3 are used to measure low pressures up to a maximum of 400 mbar. The medium being measured must be dry and clean.

Pressure gauge with Bourdon tube RFM

Pressure gauges with a Bourdon tube to EN 837-1 are used to measure high pressures up to a maximum of 16 bar.

A manual cock DH or a pressure gauge shut-off valve MH may be installed between the measuring line and the pressure gauge as a shut-off device to protect the pressure gauge from pressure fluctuations.

1.1 Application examples

1.1.1 Low gas pressure monitoring

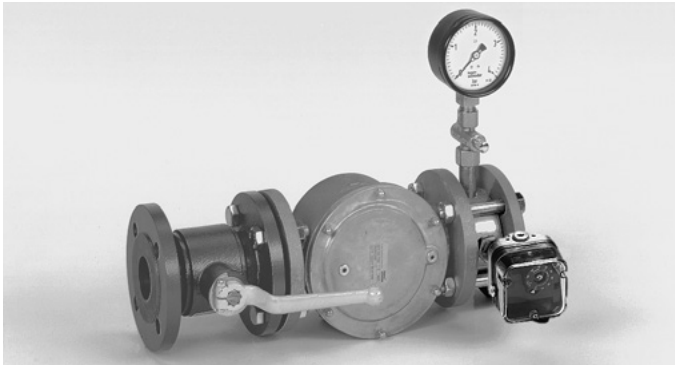

For monitoring the minimum gas inlet pressure using manual cock DH

1.1.2 Differential pressure monitoring

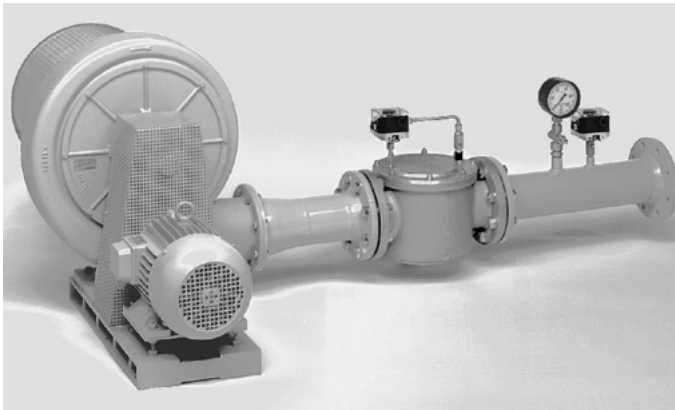

Display of the combustion air supply

1.1.3 Systems leak tightness check

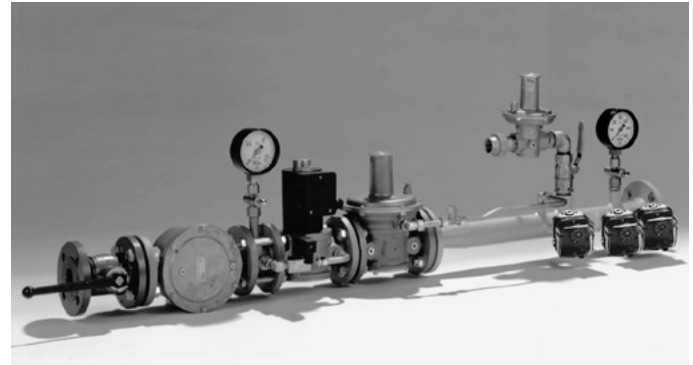

Electronic safety shut-off valve SAV with leak tightness check of downstream devices

2 Certification

Certificates – see Docuthek.

Under the Pressure Equipment Directive 2014/68/EU, Article 3 and Annex II, Diagram 1, pressure measuring instruments with a display range of ≤ 200 bar come under Article 3.3 of the Directive and must not bear a CE mark.

DH: meets the requirements of



- Gas Appliances Directive (2009/142/EC)

DH, MH: meet the requirements of

- DVGW VP 308:2004

Eurasian Customs Union



The products DH, MH 15 and UDS meet the technical specifications of the Eurasian Customs Union.

Metrological certificate

The products KFM and RFM hold a metrological certificate in accordance with the Russian standard.

The product KFM holds a metrological certificate in accordance with the Belorussian standard.

3 Function

3.1 RFM

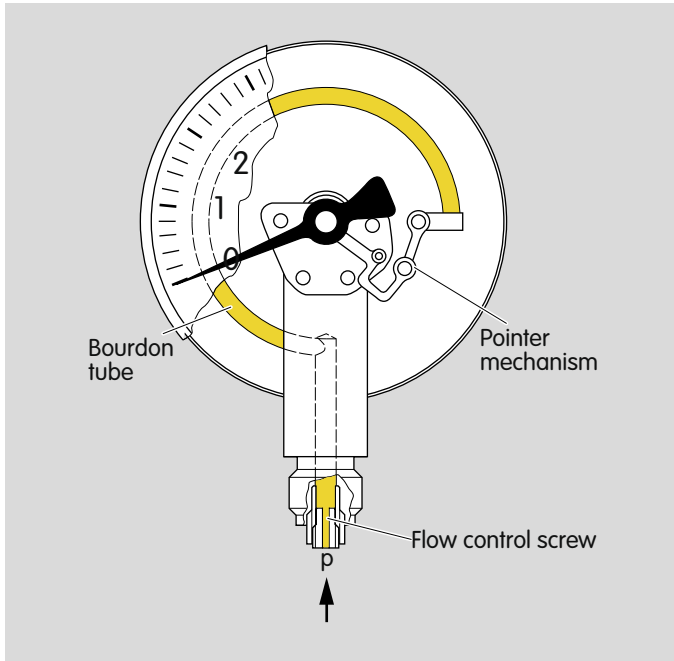

A flow control screw can be used as a damping unit to counteract brief pressure surges.

The RFM is also available on request in a chemical-industry version with the housing and measuring system made of stainless steel.

The measuring element of a Bourdon tube pressure gauge is a circular or spiral tube bent in the shape of a C as shown.

When pressurized, the Bourdon tube attempts to unwind to reach its initial position. The resulting distance, an increase in the radius, affects the pointer mechanism and ultimately causes a circular motion which can be read on the indicator.

3.2 KFM

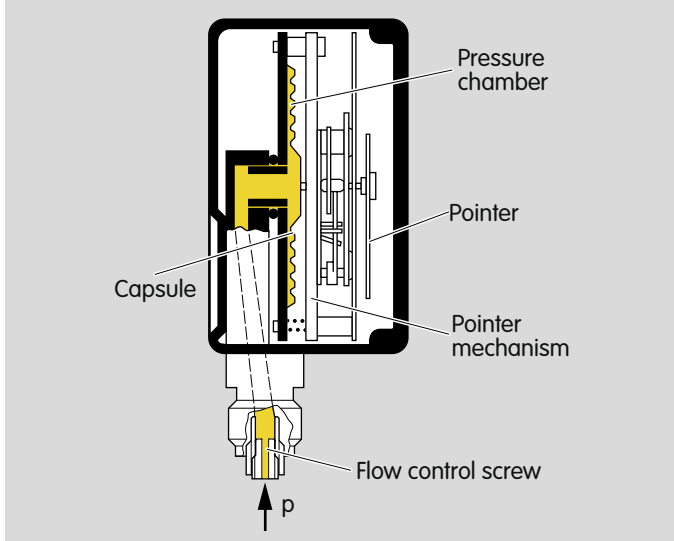

The resulting lifting motion is transferred to a pointer mechanism and ultimately causes a circular motion which can be read on the indicator.

The KFM is also available on request in a chemical-industry version with the housing and measuring system made of stainless steel.

There is an enclosed pressure chamber (load cell) in the pressure gauge with capsule element KFM. A flow control screw can be used as a damping unit to counteract brief pressure surges. On the KFM, the flow control screw is installed as standard with a bore hole diameter of 0.3 mm.

The load cell consists of a diaphragm which is soldered to a base plate. The gas for measuring is fed into the load cell through an opening. When pressurized, the load cell deforms outwards.

4 Selection

4.1 KFM, RFM

The display range should be selected so that the maximum load does not exceed 75% of the scale value when subjected to a static load or 65% of the scale value when subjected to a dynamic load.

4.1.1 Selection table

	25 - 400	0,6 - 16	0,6 - 5	10 - 230	R	TN	B	U	63	100	M*
KFM	●	●			●		●	○	●		○
RFM		●			●		●		●	●	○
KFM P			●			●	●		●	●	○
RFM P				●		●	●		●	●	○

● = standard, ○ = available

* On request

Order example

KFM 25RB63

4.1.2 Type code

Code	Beschreibung
KFM	Kapselfedermanometer
RFM	Rohrfedermanometer
P	T-Programm
	Messbereich KFM:
20	-20 bis +20 bar
25	0 bis 25 mbar
40	0 bis 40 mbar
60	0 bis 60 mbar
100	0 bis 100 mbar
160	0 bis 160 mbar
250	0 bis 250 mbar
400	0 bis 400 mbar
2500	0 bis 2500 Pa
	Messbereich RFM:
0,6	0 bis 0,6 bar
1,6	0 bis 1,6 bar
4	0 bis 4 bar
6	0 bis 6 bar
10	0 bis 10 bar
16	0 bis 16 bar
	Messbereich KFM P:
0,6	0 bis 0,6 psi
1,0	0 bis 1,0 psi
1,6	0 bis 1,6 psi
2,5	0 bis 2,5 psi
4,0	0 bis 4,0 psi
5,0	0 bis 5,0 psi
	Messbereich RFM P:
10	0 bis 10 psi
23	0 bis 23 psi
60	0 bis 60 psi
150	0 bis 150 psi
230	0 bis 230 psi
R	Anschlusszapfen mit geradem Rohrgewinde
TN	NPT-Außengewinde
B	Überdruck
U	Überdruck und Unterdruck
63	63 mm sichtbarer Skalendurchmesser
100	100 mm sichtbarer Skalendurchmesser
M	Chemieausführung

5 Project planning information

Pressure gauges may be used only for indication and may not be used as a part of a safety device for protection against exceeding permitted limits (safety accessories).

5.1 Installation

Note wall clearance and turning radius – min. 60 mm (2.4"). The pressure vent must not be blocked by unit parts or dirt.

The pressure gauge must be mounted in a location not subject to vibration and so as to provide easy read-off. If the installation site for the pressure gauge is exposed to mechanical vibration, a pressure gauge filled with fluid must be installed.

Use approved sealing material.

Sealing material and thread cuttings must not be allowed to get into the housing! Install a filter upstream of every system.

5.2 Installation position

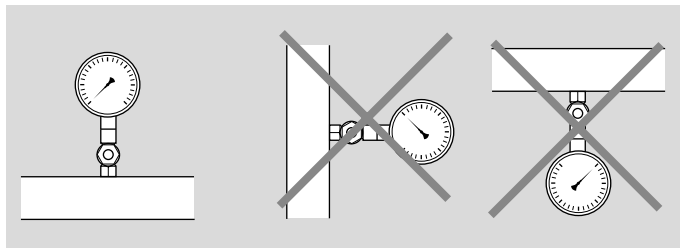

5.3 Outdoor applications

In outdoor applications, reading the indicator may be impaired by condensation.

Another possibility is to use a pressure gauge filled with glycerine. It should be noted that on pressure gauges filled with fluid, however, the viscosity of the fluid increases as the ambient temperature falls. This results in the indication being delayed.

5.4 Pressure surges

In the event of brief pressure surges in the ms range, the pressure gauge may be protected from destruction by a flow control screw. The flow control screw reduces the inlet cross-section and thus delays the pressure change in the measuring element. On the KFM, the flow control screw is installed as standard with a bore hole diameter of 0.3 mm.

In the event that high pressure prevails for lengthy periods, we recommend that you install the positive pressure protection UDS upstream of the pressure gauge, see page 11 (Accessories).

5.5 Zero point correction

A zero point connection is possible on the KFM and RFM Ø 100.

5.6 Oxygen and acetylene

Pressure measuring instruments for oxygen and acetylene are safety pattern pressure gauges and as such must comply with version S2 or S3. Wetted pressure gauge components must be kept free of oil and grease. Only lubricants which are suitable for oxygen at maximum operating pressure may be used.

The dials must be marked with the word “Oxygen” in English and the international symbol for “Free of oil and grease” (symbol O248 to ISO 700 with a prohibition sign).

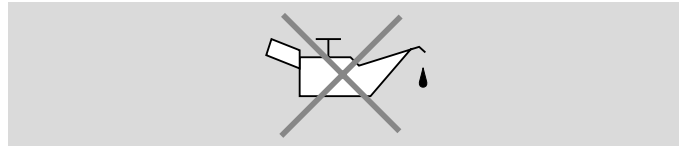

5.6.1 Safety pattern version

Code	Explanation
0	Pressure gauge without discharge bore
S1	Pressure gauge with discharge bore
S2	Safety pattern pressure gauge without fracture-proof partition
S3	Safety pattern pressure gauge with fracture-proof partition

5.7 Discharge bore

There is a discharge bore on the housing of the RFM. We recommend that the device is vented by cutting off the nipple on the filler plug for internal pressure compensation.

5.8 Indicating accuracy

5.8.1 Indicating error

An error limit is shown on the dial of the pressure gauge which applies in an ambient temperature of +20°C. Different temperatures will affect the pressure gauge's indicator. The maximum admissible deviation is around +0.4% of the full scale value if the temperature increases by 10°C. If the temperature falls by 10°C, it is around -0.4% of the full scale value.

5.8.2 Accuracy classes

The accuracy class defines the error limit for a positive and negative deviation from the measured value in percent, see page 13 (Indicating accuracy).

6 Accessories

6.1 Manual cock DH

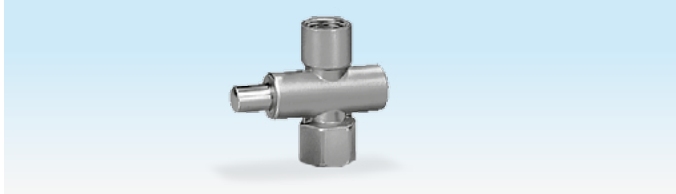

The manual cock DH is used as a shut-off device between the measuring line and the pressure gauge. This means that the pressure gauge is permanently depressurized. Press the push-button to pressurize the pressure gauge and display the operating pressure.

6.1.1 Technical data

For natural gas, town gas, LPG (gaseous) and air.

Ambient temperature: 0 to +70°C (32 to 158°F).

Max. inlet pressure p_U : 4 bar (58 psi).

Connection: DH 8R50: Rp ¼ (NPT ¼),
DH 15R50: Rp ½ (NPT ½).

Material: brass, nickel-plated.

DH 8R50: Order No. 03152141,

DH 15R50: Order No. 03152149,

DH 8TN50: Order No. 03152142,

DH 15TN50: Order No. 03152155.

6.2 Pressure gauge shut-off valve MH

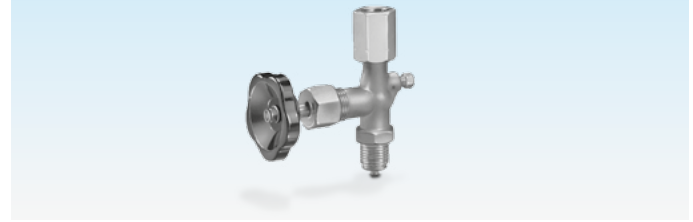

The pressure gauge shut-off valve MH can be used for pressures of up to a maximum of 100 bar. The enclosed pressure between the pressure gauge and valve can be vented using the hexagon head screw on the MH to correct the zero point on the pressure gauge.

6.2.1 Technical data

For natural gas, town gas, LPG (gaseous) and air.
MH..M: biogas.

Ambient temperature: -10 to +70°C (50 to 158°F).

Max. inlet pressure p_U : 100 bar (1450 psi).

Connection: G ½, DIN ISO 228, Part 1.

Material:

MH: brass,

MH..M: stainless steel 1.457.

MH 15: Order No. 03150191,

MH 15M, for aggressive media: Order No. 03150192.

6.3 Pressure gauge seal

A seal must be inserted between the pressure gauge and manual cock DH.

¼" connection, Cu: Order No. 03110617,

½" connection, Cu: Order No. 03110615,

biogas, ½" connection, PTFE: Order No. 03110711.

6.4 Positive pressure protection UDS

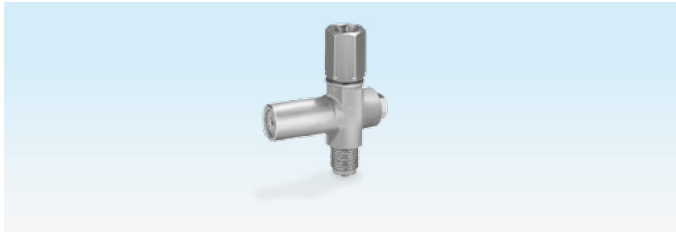

The positive pressure protection UDS closes and protects the pressure gauge against damage as soon as excess pressures exceed the set lock-up pressure on the UDS.

The UDS has an external G ½ thread.

Material:

UDS: brass,

UDS..M: stainless steel 1.457.

	Adjusting range
UDS 2,5	0.4 – 2.5 bar (5.8 – 36.3 psi)
UDS 6,0	2 – 6 bar (29 – 87 psi)
UDS 25	5 – 25 bar (72.5 – 363 psi)

UDS 2,5: Order No. 03150621,

UDS 6,0: Order No. 03150623,

UDS 25: Order No. 03150625.

For aggressive media:

UDS 2,5M: Order No. 03150622,

UDS 6,0M: Order No. 03150624,

UDS 25M: Order No. 03150626.

The UDS is set to the adjusting range mid-point at the works.

7 Technical data

Gas types: natural gas, LPG (gaseous) or clean air; other gases on request. The gas must be clean and dry in all temperature conditions and must not contain condensate.

Ammonia and hydrogen (chemical-industry version): wetted parts must be made of stainless steel.

Scope of application in accordance with EN 837-2: the medium pressure to be measured may exceed the full scale value of the pressure gauge only as the result of brief pressure surges.

	Load type		
	Steady state	Alternating	Brief duration
KFM, RFM	0.75 x full scale value	0.67 x full scale value	1.3 x full scale value

Indicating accuracy

	Class	Indicating error (standard temp. + 20°C)
KFM	1.6	± 0.6% of full scale value per 10°C temperature fluctuation
RFM..63	1.6	± 0.4% of full scale value per 10°C temperature fluctuation
RFM..100	1.0	± 0.4% of full scale value per 10°C temperature fluctuation

Safety pattern version to EN 837-2

Medium	Gas (not for oxygen and acetylene)	
Housing	not filled with fluid	
Type	KFM..63, RFM..63	KFM..100, RFM..100
Indicating range	≤ 25 bar (363 psi)	≤ 25 bar (363 psi)
Safety version*	0	S1

* 0 = Pressure gauges without discharge bore

S1 = Pressure gauges with discharge bore

Medium and ambient temperatures:

-20 to +60°C (-4 to +140°F).

Storage temperature: -20 to +40°C (-4 to +104°F).

Enclosure:

KFM..63, RFM..63: IP 32,

KFM..100, RFM..100: IP 54.

Connection

	Brass connection	EN 837	A/F
KFM..100	G ½B	Part 3	A/F 22
KFM..63	G ¼B	Part 3	A/F 14
RFM..100	G ½B	Part 1	A/F 22
RFM..63	G ¼B	Part 1	A/F 14

Housing: stainless steel.

Weight:

KFM..63: 189 g (0.416 lbs),

KFM..100: 474 g (1.04 lbs),

RFM..63: 136 g (0.299 lbs),

RFM..100: 531 g (1.17 lbs).

7.1 Dimensions

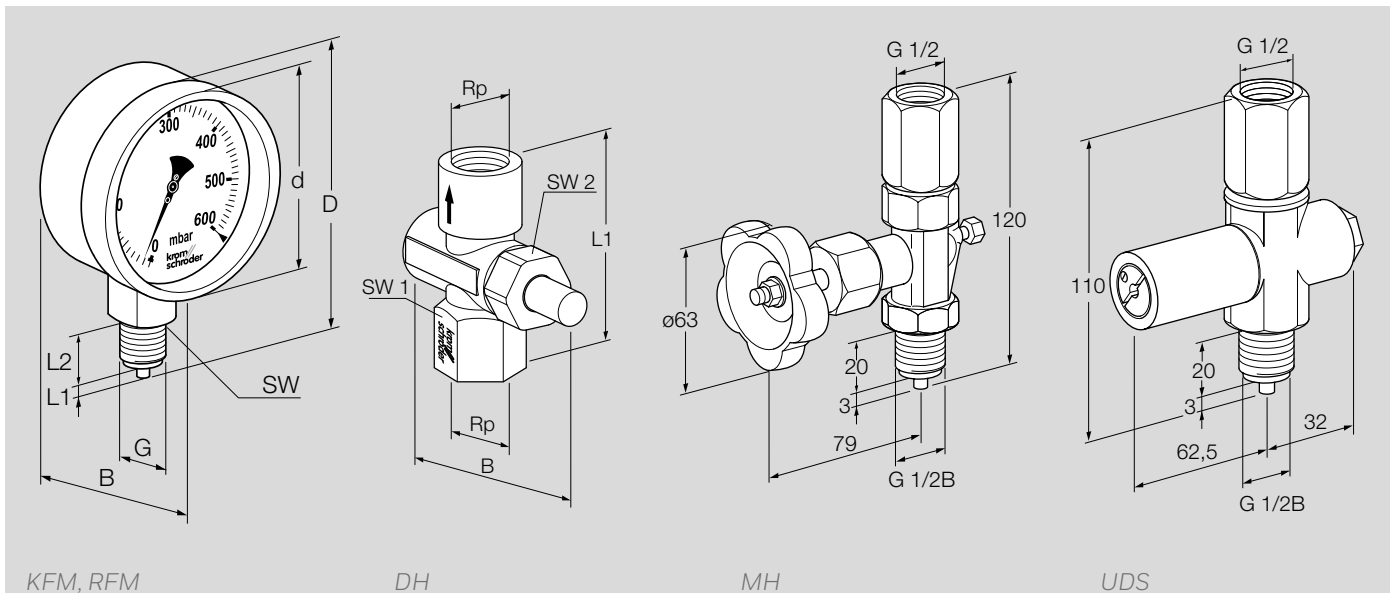

Type	R connection	d	D	B	L1	L2	SW
KFM ..63, RFM ..63 KFM P..63TN, RFM P..63TN	G 1/4B NPT -18	63 mm 2.5"	86 mm 3.4"	29.5 mm 1.2"	2 mm 0.08"	13 mm 0.5"	A/F 14
KFM ..100, RFM ..100 KFM ..100TN, RFM ..100TN	G 1/2B NPT -14	100 mm 3.9"	139.5 mm 5.5"	49 mm 1.9"	3 mm 0.12"	20 mm 0.8"	A/F 22

Type	Rp connection	B	L	SW 1	SW 2
DH 8 DH 8TN	Rp 1/4 1/4 NPT	64 mm 2.5"	53.5 mm 2.1"	A/F 19	A/F 22
DH 15 DH 15TN	Rp 1/2 1/2 NPT	64 mm 2.5"	71.5 mm 2.8"	A/F 19	A/F 26

8 Converting units

See www.adlatus.org

9 Maintenance cycles

We recommend a function check once a year.

Feedback

Finally, we are offering you the opportunity to assess this “Technical Information (TI)” and to give us your opinion, so that we can improve our documents further and suit them to your needs.

Clarity

- Found information quickly
- Searched for a long time
- Didn't find information
- What is missing?
- No answer

Comprehension

- Coherent
- Too complicated
- No answer

Scope

- Too little
- Sufficient
- Too wide
- No answer



Use

- To get to know the product
- To choose a product
- Planning
- To look for information

Navigation

- I can find my way around
- I got “lost”
- No answer

My scope of functions

- Technical department
- Sales
- No answer

Remarks

Contact

Elster GmbH
Postfach 2809 · 49018 Osnabrück
Strothweg 1 · 49504 Lotte (Büren)
Germany

Tel +49 541 1214-0
Fax +49 541 1214-370
hts.lotte@honeywell.com
www.kromschroeder.com

The current addresses of our international agents are available on the Internet:
www.kromschroeder.de/Weltweit.20.0.html?&L=1

We reserve the right to make technical modifications in the interests of progress.
Copyright © 2017 Elster GmbH
All rights reserved.

